

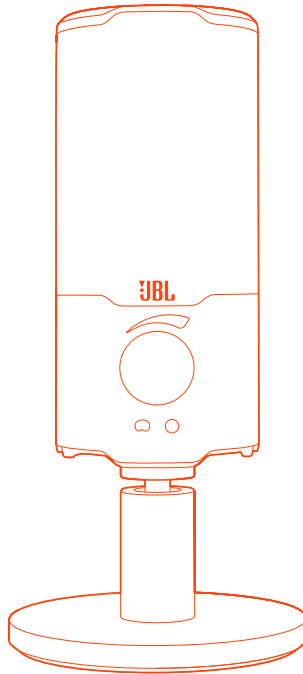

JBL QUANTUM Stream



OWNER'S MANUAL

TABLE OF CONTENTS

INTRODUCTION	1
WHAT'S IN THE BOX.....	2
PRODUCT OVERVIEW	3
Controls	3
GETTING STARTED.....	4
System compatibility	4
Connecting USB power cable	4
Connecting a monitoring headphone	5
First-time setup (for PC only).....	5
USING YOUR MICROPHONE	7
Selecting a polar pattern	7
Positioning	8
MOUNTING OPTIONS	10
Mic mount with 5/8" male screw	10
Mic mount with 1/4" male screw	11
Shock mount for 2.2" diameter microphones	12
PRODUCT SPECIFICATIONS.....	13
TROUBLESHOOTING	14

INTRODUCTION

Congratulations on your purchase! This manual includes information on the JBL Quantum Stream microphone. We encourage you to take a few minutes to read this manual, which describes the product and includes step-by-step instructions to help you to set up and get started. Read and understand all the safety instructions before using your product.

If you have any questions about this product or its operation, please contact your retailer or customer service, or visit us at www.JBLQuantum.com

WHAT'S IN THE BOX

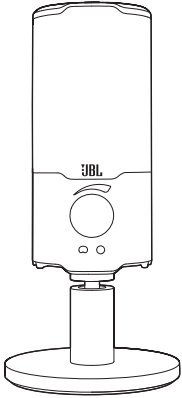

01



02







03

- 01 JBL Quantum Stream microphone
- 02 USB power cable (USB-A to USB-C)
- 03 QSG, warranty card and safety sheet

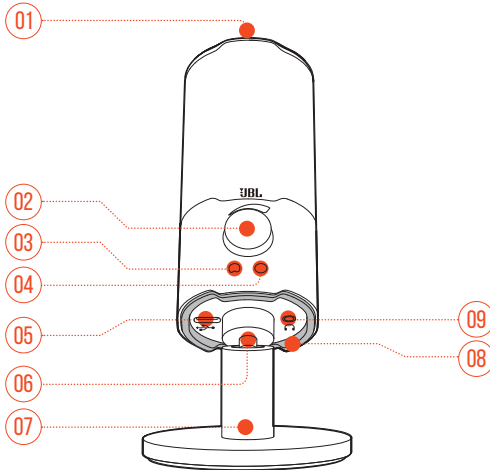
PRODUCT OVERVIEW

CONTROLS



- 01  Mutes or unmutes the microphone.
- 02 **Volume knob**
 - Adjusts headphone volume.
- 03 
 - Lights up white when the polar pattern is cardioid (default).
- 04 
 - Lights up green when the polar pattern is omnidirectional.
- 05 **USB-C port**
- 06 **Rotary joint**
- 07 **Microphone stand**
- 08 **Ring LED (RGB lighting + mute/unmute indicator)**
- 09 **3.5 mm headphone port**

GETTING STARTED

SYSTEM COMPATIBILITY

- PC and Mac (desktop or laptop) with USB-A or USB-C ports
- Mobile devices with USB-C ports
- PlayStation™: PS4/PS5 console with USB-A port
- Nintendo Switch™ with USB-C port and Nintendo Switch™ console with USB-A port

CONNECTING USB POWER CABLE

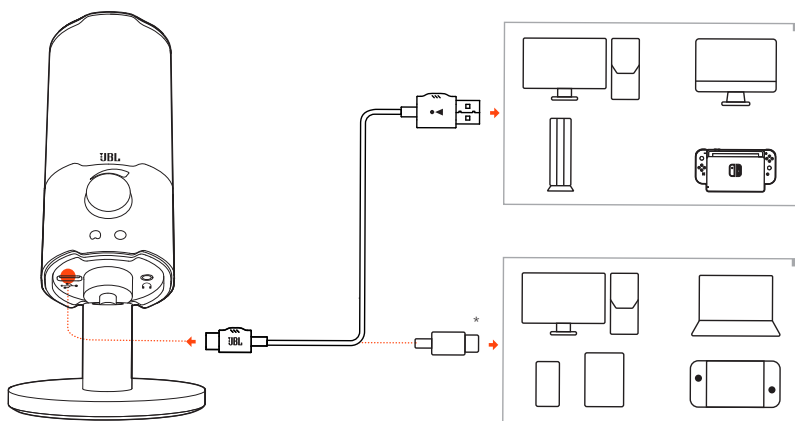

1. Connect the black connector (USB-C) to your microphone.
 2. Connect the orange connector (USB-A) to your PC, Mac, PS4/PS5 console or Nintendo Switch™ console.
- You can also use a USB-C to USB-C cable to connect the microphone to compatible devices.
 - ↳ The microphone powers on.

NOTE:

- USB-C to USB-C cable is not included by-pack. Connectivity with USB-C may not work with all models of said devices.

CONNECTING A MONITORING HEADPHONE

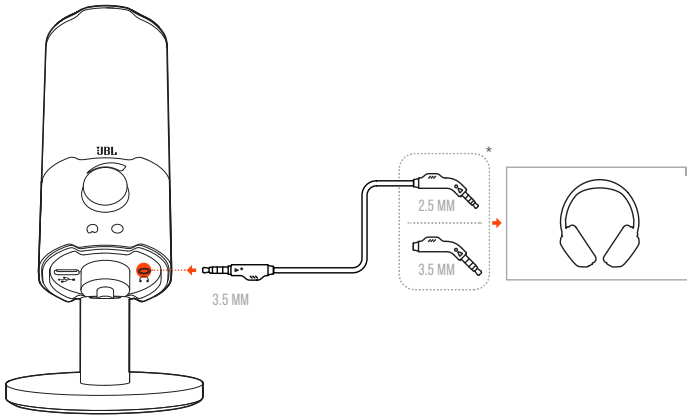

1. Connect a 3.5mm to 3.5mm cable or a 3.5mm to 2.5mm cable to the headphone port on the microphone.
2. Connect the other end to a monitoring headphone.
 - ↳ You can hear sounds from the microphone.

FIRST-TIME SETUP (FOR PC ONLY)

Download **JBL QuantumENGINE** from www.jblquantum.com/engine to gain full access to features on your JBL Quantum Stream, such as EQ settings, polar pattern selection and lighting customization.

SOFTWARE REQUIREMENTS

Platform: Windows 10 (64 bit only) / Windows 11

500MB of free hard drive space for installation

1. Connect the microphone to your PC via USB connection. (See ["Positioning"](#)).
2. Go to **"Sound Settings"** -> **"Sound Control Panel"**.
3. Under **"Playback"** highlight **"JBL Quantum Stream"** and select **"Set Default"** -> **"Default Device"**.
4. Under **"Recording"** highlight **"JBL Quantum Stream"** and select **"Set Default"** -> **"Default Device"**.
5. Follow the onscreen instructions to personalize your sound settings.

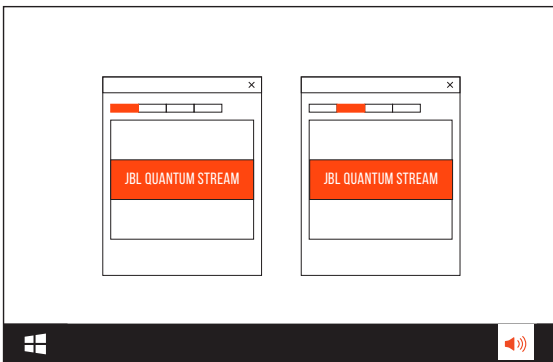



NOTE:

- By default, all sounds will be played through the JBL Quantum Stream microphone and heard through a headphone connected to it. To hear sound from the PC directly, select the PC sound card as the default device.

POSITIONING



For optimal performance, speak towards the side instead of the top of the microphone.

Recommended	Not recommended
	

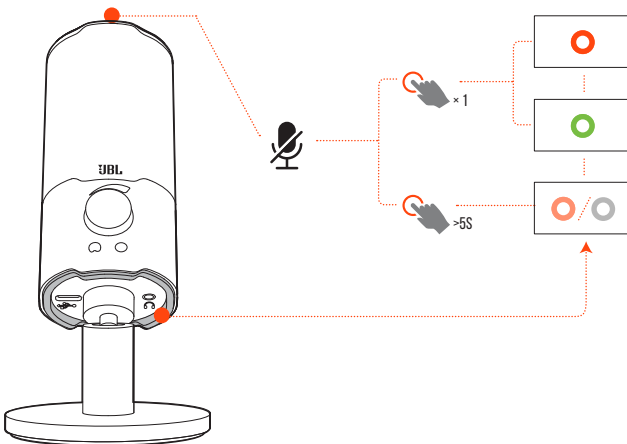

MUTE/UNMUTE



- Press  on the top to mute or unmute the microphone.

Ring LED color	Meaning	Microphone status
	RGB lighting on, mute/unmute indicator in red	Muted
	RGB lighting on, mute/unmute indicator in green	Unmuted

- Hold  for 5 seconds to turn off RGB light on the ring LED. Hold the same button for 5 seconds to turn it on again.

Ring LED color	Meaning	Microphone status
	RGB lighting off, mute/unmute indicator in red (30% brightness)	Muted
	RGB lighting off, mute/unmute indicator off	Unmuted

VOLUME/GAIN ADJUSTMENT

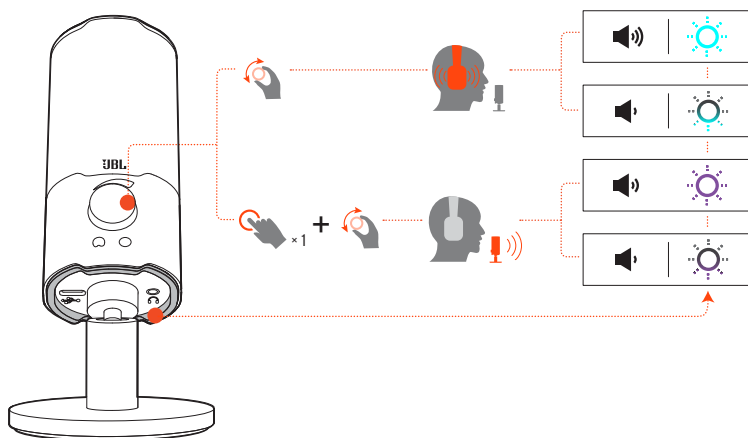

To adjust the headphone and sidetone volume:

- Rotate the volume knob clockwise or counterclockwise.
 - ↳ The side tone is off by default. You can enable sidetone in QuantumEngine and then rotate the volume knob to adjust sidetone volume.
 - ↳ The RGB light on the ring LED flashes in bright teal when the maximum volume is reached. It flashes in dim teal when the minimum volume is reached.

To adjust the microphone gain:

- Press the volume knob, then rotate it clockwise or counterclockwise.
 - ↳ The RGB light on the ring LED flashes in bright purple when the maximum gain is reached. It flashes in dim purple when the minimum gain is reached.

MOUNTING OPTIONS

You can either place the microphone on an even surface directly or mount it with compatible accessories (not included).

MIC MOUNT WITH 5/8" MALE SCREW

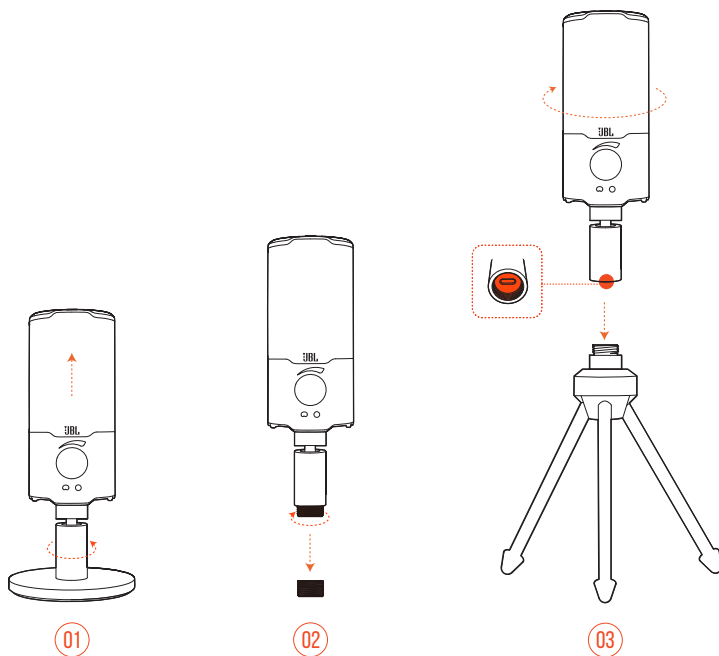

1. Detach the microphone and connecting rod from the round base.
2. Remove the male threaded bolt from the connecting rod to expose the 5/8" (15.88 mm) female thread.
3. Attach the microphone and connecting rod onto a mic mount (a tripod or boom arm etc.) with 5/8" (15.88 mm) male screw securely.

MIC MOUNT WITH 1/4" MALE SCREW

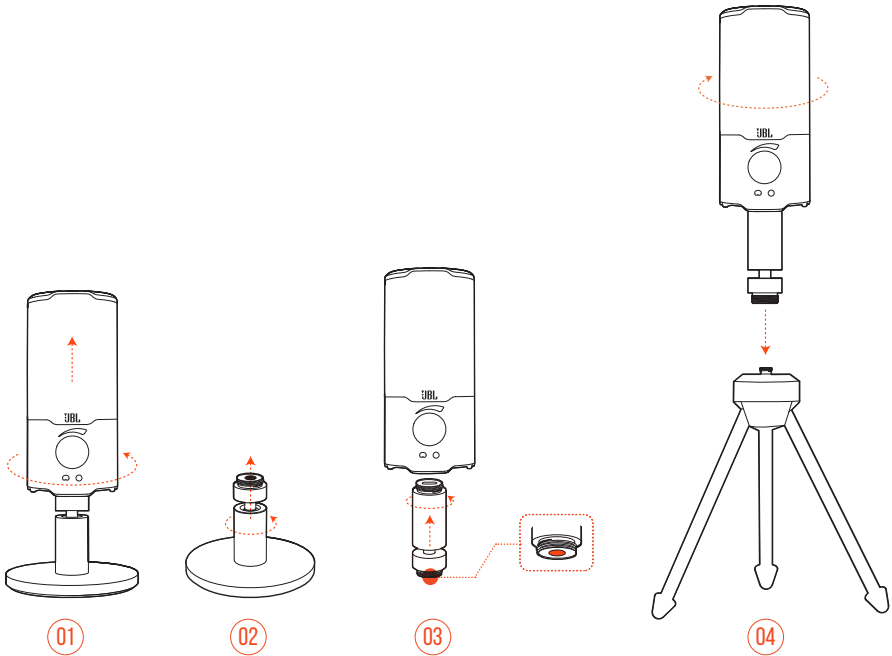

1. Detach the microphone from the connecting rod.
2. Detach the connecting rod from the round base.
3. Attach the connecting rod to the microphone with the 1/4" (6.35 mm) female thread exposed.
4. Attach the microphone and connecting rod onto a mic mount (a tripod or boom arm etc.) with 1/4" (6.35 mm) male screw securely.

SHOCK MOUNT FOR 2.2" DIAMETER MICROPHONES

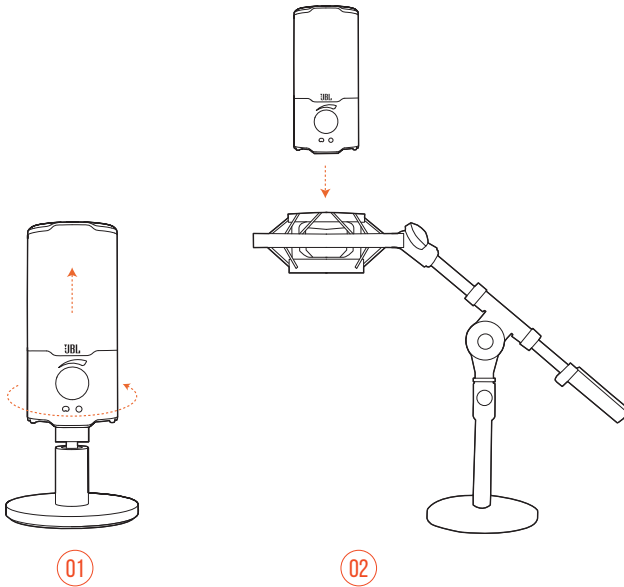

1. Detach the microphone from the connecting rod.
2. Attach the microphone onto a shock mount supporting 2.2" (55 mm) diameter microphones securely.

PRODUCT SPECIFICATIONS

MICROPHONE

- Power required/consumption: 5 V \approx 500 mA
- Sample rates: 44.1 kHz / 48 kHz / 96 kHz
- Bit rate: 16 / 24 bit
- Capsules: 14 mm Electret Condenser Microphone
- Polar patterns: Cardioid & Omni-directional
- Frequency response: 20 Hz - 20 kHz
- Sensitivity: -37 ± 3 dB (1 kHz@1 Pa, 0 dB = 1 v/Pa)
- Maximum SPL: 110 dB

HEADPHONE AMPLIFIER

- Impedance: >16 ohm
- Power output (RMS): 45 mWrms per channel (Load = 32 ohms)
- THD: <0.5% (Load = 32 ohms)
- Frequency response: 20 Hz - 20 kHz
- Signal to noise: 90 dB (A weighted)

DIMENSIONS - MIC WITH STAND

- Dimensions (L x W x H): 8 cm x 8 cm x 17.43 cm / 3.15" x 3.15" x 6.86"
- Weight: 248 g / 0.547 lbs

NOTE:

- Technical specifications are subject to change without prior notice.

TROUBLESHOOTING

If you have problems using this product, check the following points before you request service.

NO POWER

- Make sure that the microphone is properly connected and compatible with your PC, Mac or gaming console device.

NO SOUND FROM MY HEADPHONE

- Make sure that the microphone is properly connected to your headphone and PC, Mac or gaming console device.
- Make sure that you have chosen **JBL Quantum Stream** as the sound source of your PC, Mac or gaming console device.
- Adjust volume on your headphone and make sure that your microphone is not muted.

SPEAKER FEEDBACK

- This happens when the speaker sound is picked up by your microphone and sent back to the speaker after being re-amplified. Try the following to eliminate speaker feedback:
 - Adjust the position so that the speaker is not too close to the microphone and does not point at the microphone directly.
 - Decrease the speaker volume and microphone gain to an appropriate level.

DISTORTED SOUND

- Decrease the microphone gain to an appropriate level.
- Adjust the microphone position so that it is not too close to the sound source.

POOR SOUND OR SOUND NOT LOUD ENOUGH

- Increase the microphone gain to an appropriate level.
- Move the microphone closer to the sound source.
- Select an appropriate polar pattern.
- Speak towards the side instead of the top of the microphone.

MY VOICE CANNOT BE HEARD BY MY TEAMMATES

- Make sure that you have chosen **JBL Quantum Stream** as the recording device in the sound settings of your PC, Mac or gaming console device.
- Make sure that the microphone is not muted.

I CAN'T HEAR MYSELF WHEN I'M TALKING

- The sidetone is off by default. You can enable sidetone in QuantumEngine and then rotate the volume knob to adjust sidetone volume.

